

A Design-Oriented Model of Plate Forming for Shipbuilding

David Hardt,¹ Andrew Wright,¹ and Edward Constantine¹

Ship designers as well as product designers in general are most concerned with the function and form of the design, and typically cannot pay adequate attention to the manufacturing consequences of their design decisions. Much of this problem can be alleviated by providing the designer with new tools that allow easy, yet thorough exploration of material and process options as part of the design process. This paper presents a prototype of such a tool, aimed at providing process information about bending and rolling of plate. The model presented is derived from first principles of mechanics and can provide a plethora of information. However, the unique aspect of this work is the development and presentation of design-oriented information, such as optimization tradeoffs of process/material selection, and process control options ranging from purely manual to mechanized to fully automatic.

Introduction

IN SHIPBUILDING, as in general manufacturing, it is often difficult to address process-oriented issues at the design stage. The designer's efforts are generally focused on the form and function of the marine structure, and little attention is paid to evaluating how design decisions affect the actual shipbuilding. Ship designers have very few analytical tools with which to evaluate these process-oriented effects. The hypothesis here is that given appropriate process simulations, a designer could make choices which would also reflect fabrication considerations. This work concentrates on developing such tools.

The current scope of this research involves plate cutting and forming processes. Functional models have been developed for the processes of sequential bending and roll forming of metal plate for submarine hulls, and ongoing work is also directed at modeling typical plate cutting processes. A detailed discussion of the sequential bending model and its experimental verification is included in this paper along with a short description of the roll bending model.

It is essential to provide process models which, in an interactive format, allow the designer to accomplish several related tasks. First, the models permit a "single run" simulation of the process in which output geometry, stress state, and deviation from specifications can be evaluated for a particular set of input parameters. As an extension of this analysis, the models allow for "multiple run" process simulation in which typical control algorithms from operator control to fully automatic process control can be modeled and evaluated. Finally, the process models have been integrated into a wider evaluation scheme in which output data are used to generate sensitivity curves. From these curves, the designer can determine regions in which the process is less sensitive (that is, more "robust") to variations in machine and material parameters. This set of information is of considerable value at the design stage. Constructive application of simulation information should result in a more successful design that is both easier to fabricate and less likely to deviate from specifications.

¹Laboratory for Manufacturing and Productivity, Massachusetts Institute of Technology, Cambridge, Massachusetts.

Presented at the Ship Production Symposium, Arlington, Virginia, September 13-15, 1989.

Design-manufacturing integration

The research presented herein looks at the issue of design oriented process simulation. This specific area of work is focused on plate cutting, forming and limited fixturing. As previously discussed, the specific intention is to create a prototype tool with which the designer can take fabrication considerations into account at the design stage. This effort is part of a larger Office of Naval Research (ONR) sponsored project at Massachusetts Institute of Technology (MIT) which is concerned with the general issue of design-manufacturing integration in shipbuilding. This project also includes the modeling of welding distortion [1]² and complex fit-up [2]. In addition, computer-aided design (CAD) issues are addressed with the intention of providing better methods of representation for the complex geometries encountered in hull design [3]. Figure 1 illustrates how this work combines with that of fixturing and distortion modeling.

The application of process models and simulations by the designer permits the prediction of part geometry, and more importantly the prediction of deviation from desired geometry. This information is of significant interest when looking at the issue of fit-up for assembly. Proper process investigation can significantly reduce the fit-up effort. Also, the evaluation of sensitivity functions allows the designer to "discover" tradeoffs in the process and use them to advantage. These sensitivity functions can also be used to minimize forming error, as they would facilitate a choice of process operating point that is less sensitive to parameter variations such as changes in material properties.

Process models

In describing the modeling aspects of this work, it is essential to make the semantic distinction between the terms "process model" and "process simulation." In describing a process model, one generally refers to an analytical tool developed from first principles that allows for the prediction of process output characteristics for a given set of input parameters. In this case, a model accurately predicts the geometry and state of stress of a bent plate, for a given set of inputs (machine geometry and material properties). One can incorporate the model into a process simulation by looking

²Numbers in brackets designate References at end of paper.

MATERIAL PROPERTIES / VARIATIONS

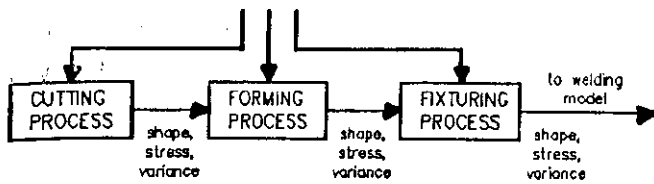

Fig. 1 Integrated weldment design system

at the actual steps involved in "using" the process at the shop floor level. Here, one would examine the sequence of steps involved in bending a plate to a desired radius. This could, for example, involve an operator control algorithm (bend, measure, rebend) or an adaptive control scheme (bend, measure, then use this information to more accurately predict performance by reestimating material parameter values). Also, one could apply the model to a closed loop, real time control scheme such as discussed in Hardt and Chen [4]. Thus, the simulation program incorporates a process model and a measurement model into a parent program which follows a particular control algorithm.

The sequential bending and roll forming models have been designed so as to permit a "non-zero" initial geometry and state of stress for the plate being bent. This feature allowed for the development of a plate bending simulation which makes use of these fundamental forming models. This simulation is of significant value to the investigative designer.

User-interface programming has been added to the simulation to permit the easy modification of model input variables and a clear display of graphic data. This interface was written so as to be model independent, making it flexible for future use. The graphics facilities have been implemented on a DEC VaxStation 3200 in the Ultrix/X-Windows environment, with all programs written in "C." Figure 2 illustrates the overall arrangement of the process model in an integrated process simulation program, and Fig. 3 shows the basic display screen available on the engineering workstation.

Sequential bending model

The process of plate bending to achieve a circular hull section involves creating a series of overlapping plastic deformation zones to achieve an acceptable average curvature. However, unlike roll bending, this process will not produce a uniform curvature with arc length, but will instead result in a periodic variation in curvature about an average value. The following model has been developed to allow a process designer to examine the effect of machine geometry, bend line spacing and punch penetration on both the average and continuous curvature distribution along the arc length of the part. To assess the amount of yard-level control that will be necessary to achieve tolerance on a part (or alternatively the

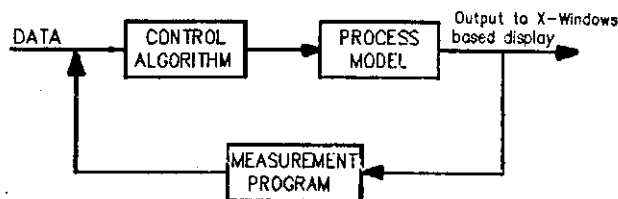

Fig. 2 Simulation block diagram

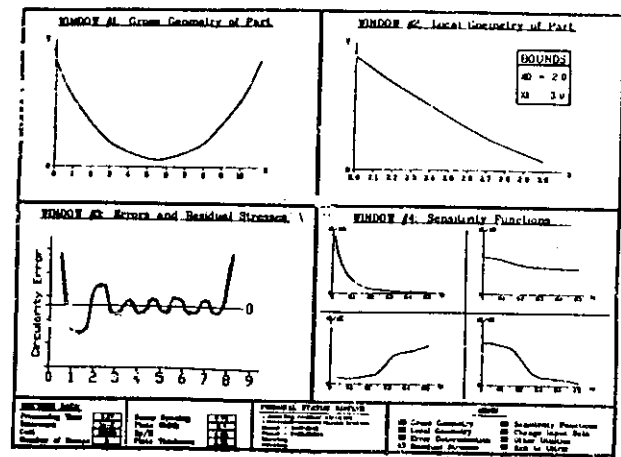

Fig. 3 Sample simulation screen

achievability of a part tolerance), the model is used as well to calculate local gradient in outputs with respect to process parameters of material yield strength (σ_y) thickness (t) and machine control accuracy via the punch displacement (Y_p).

The geometry of the bending process is simple three-point beam bending as shown in Fig. 4. As the punch penetrates into the workpiece, the maximum bending moment (under the punch) increases. If a linear moment distribution with arc length is assumed (as done in all similar bending analyses [5,6,7]), then a corresponding loaded curvature distribution can be found given the basic constitutive relationship for the material, which for bending is the moment-curvature relationship. (Note that the latter is typically derived from stress-strain information assuming simple beam theory and pure moment bending. Although the influence of large deflections and transverse shear is important, it is assumed herein that such effects are of second order to this analysis.)

The bending model used here starts with a given machine geometry (die half-width a) and material properties (based on a linear strain hardening material model with elastic modulus E_e , plastic modulus E_p , and yield stress σ_y), and is then driven by a specified punch penetration Y_p . The max-

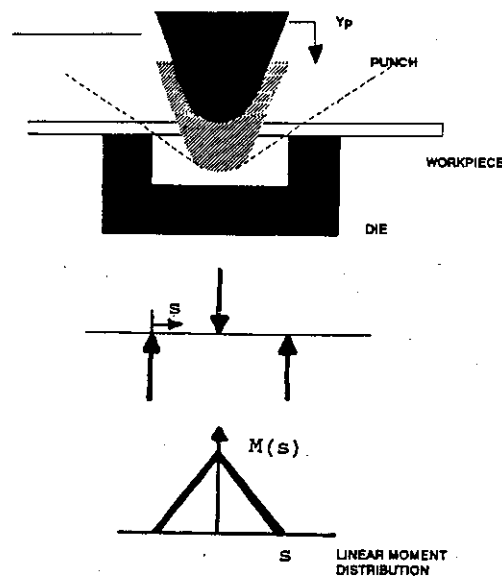

Fig. 4 Basic geometry of bending

moment M_{max} is then matched to Y_p by an iterative series of calculations that integrates the curvature to find the center point deflection. Given M_{max} and the resulting linear moment distribution across the plate: $M(s)$, the $M-K$ relationship can be applied to find the corresponding loaded curvature $K_1(s)$. Finally, the unloaded curvature distribution, $K_u(s)$ is found by applying an elastic moment of equal and opposite magnitude to the original load to account of the elastic springback. Thus we obtain:

$$K_u(s) = K_1(s) - \frac{M(s)}{S_e}$$

where $S_e = EI(1 - \nu^2)$ is the equivalent bending stiffness of the plate section.

The key output of the model at this stage is, therefore, the curvature distribution $K_u(s)$ that results from a single bend. A typical result is shown in Fig. 5 where the effect of springback is evidenced by the lack of permanent curvature change at the periphery of the die region. Also shown in the figure is the superposition of a sequence of identical bends to produce the desired average curvature. However, this figure does not accurately represent the process of deformation overlap that is the heart of sequential bending.

To appreciate this effect, consider the problem of the first few bends of a flat plate. After the first bend, the plate now has some initial curvature (Fig. 6). When it is incremented along the line of curvature, and the next punch penetration occurs, two important changes have occurred. First, much of the material that will be plastically deformed was also deformed on the previous step, and has potentially undergone strain hardening and certainly contains residual stresses. More importantly, the point of contact of the punch on the plate is lower than for a flat plate, and since the process is controlled on the basis of absolute punch position, this means a lesser effective penetration for a preformed piece than for a flat sheet.

Such effects must be included to properly simulate this process, as the curvature distribution of Fig. 7 illustrates. Here a fixed punch penetration has been used for successive bends. The above effect is immediately obvious since the first "bump" is of high magnitude (since the plate was flat) and the next bump is smaller owing to less "effective" penetration. Then a steady state is reached as each sequence leads to a consistent initial geometry.

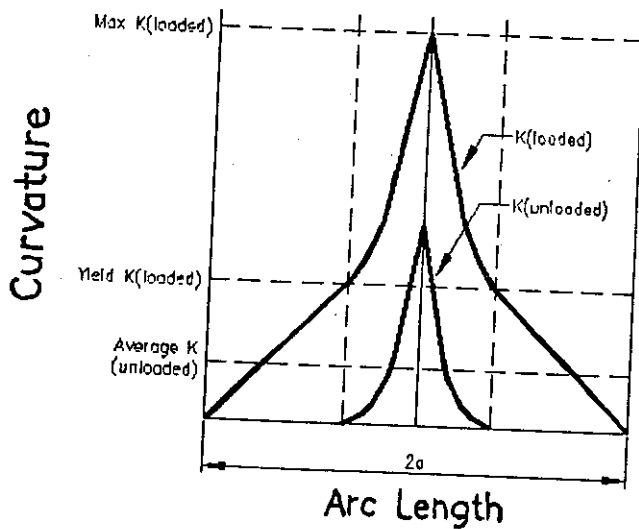

Fig. 5 Single bend curvature distribution

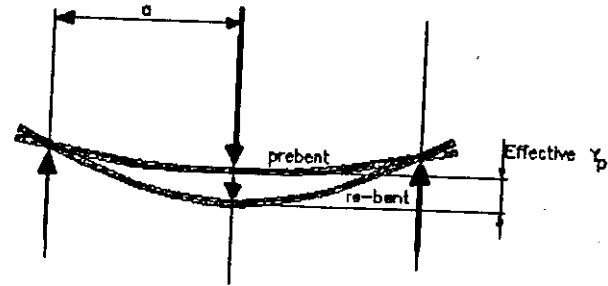
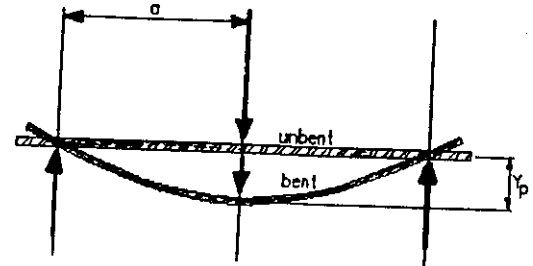

Fig. 6 Effect of prebend

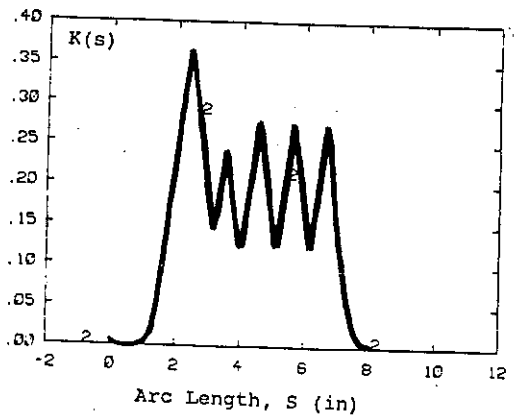

Fig. 7 Total bump sequence

As currently implemented, the model accepts a punch penetration and a bend spacing as inputs, the prebend plate curvature and residual stress state as in-process inputs, and produces outputs of curvature distribution, $K(s)$, part geometry, (x,y) , and residual stresses, $\sigma_r(y,s)$. The model parameters include the plate properties (modulus, yield point, thickness, and strain hardening properties). This model structure is shown in Fig. 8.

The analytical details of the model and its solution details are found in [8]. However, the basic structure of the solution is shown in Fig. 9, where the multiple iterative solutions are shown. These are necessitated by the indeterminate nature of the punch penetration-plate curvature relationship.

A typical set of results from the model is shown in Fig. 10. Here, a sequence of five bends spaced 1 in. apart on 1/4 in. HY 80 is simulated. The punch penetration is fixed at 0.25 in. and is kept constant. Thus, following the above definitions, this is a use of a model rather than a simulation, since the latter would vary penetration to achieve a desired curvature. Figure 11 shows the net effect of all five bends in Cartesian coordinates.

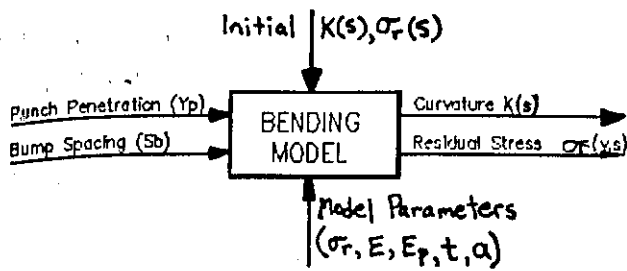

Fig. 8 Bending model structure

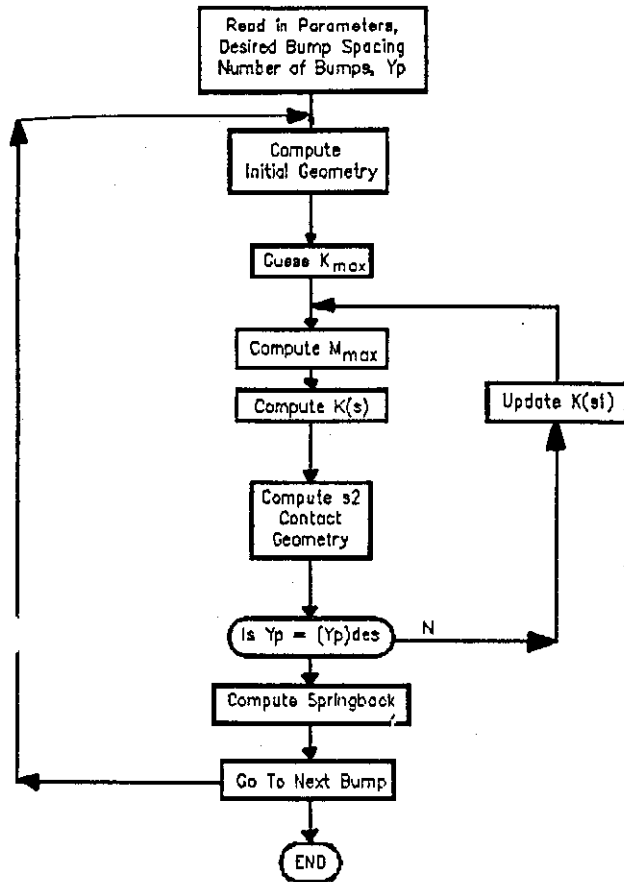

Fig. 9 Bump forming model flow chart

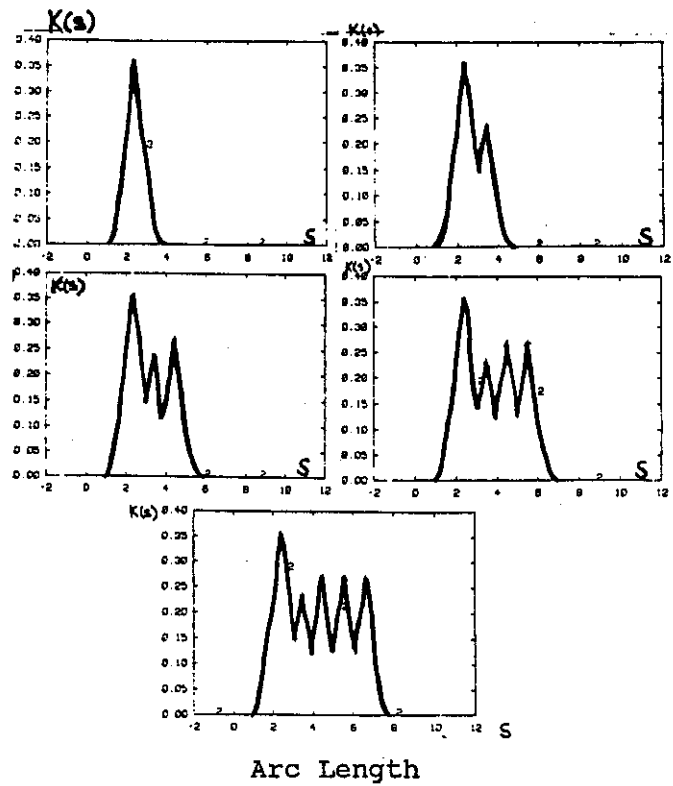

Fig. 10 Sequence of five successive bends

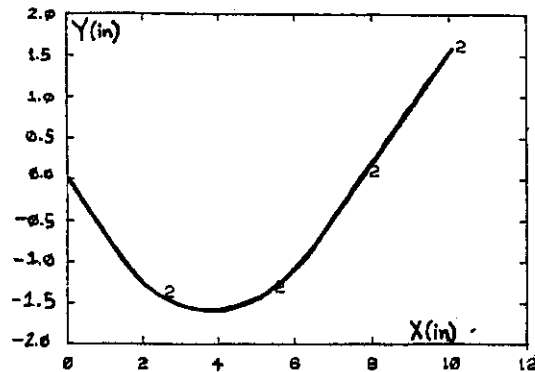

Fig. 11 X-Y profile of part

Finally, the model is used to generate sensitivity functions that will be used to aid a designer in choosing operating points for the process that minimize output variations. The iterative calculations preclude analytical gradients, and thus local gradients must be explicitly calculated by perturbing the appropriate process parameter and observing the resulting outputs change. This must then be repeated for each parameter and is valid only at a given operating point (that is, machine geometry and desired curvature). The following gradients have been generated:

$$\frac{\Delta K_{ave}}{\Delta t} \quad \frac{\Delta K_{ave}}{\Delta \sigma_y} \quad \frac{\Delta K_{ave}}{\Delta E_p}$$

$$\frac{\Delta e_R}{\Delta t} \quad \frac{\Delta e_R}{\Delta \sigma_y} \quad \frac{\Delta e_R}{\Delta E_p}$$

where e_R is defined as the deviation in radius of curvature).

By far the most sensitive quantities are those relating to thickness and plastic modulus (since strain hardening has a strong influence on the size and shape of the plastic zone during bending). Figure 12 shows typical functions for circularity and K_{ave} -thickness variations as a function of punch penetration. This figure indicates, for example, that when thickness variations are significant (as they can be with thick plate), there is an optimal punch depth/bend spacing (which is related to punch depth for a given radius) that minimizes both average curvature circularity errors.

Figure 13 illustrates the effect of changes in plastic modulus of the material on the radial or circularity error. This measures the effect of changes in the work hardening of the material on the resulting variation in curvature. Notice again the strong dependence on the operating point (punch penetration), which in this case favors the choice of a shallow punch penetration.

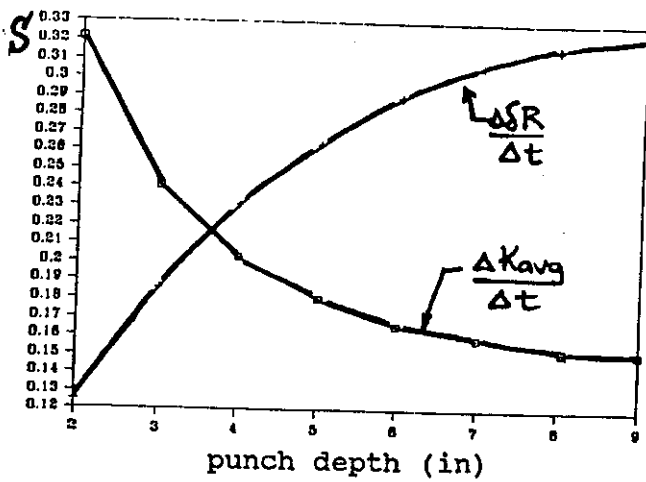

Fig. 12 Sensitivity to thickness

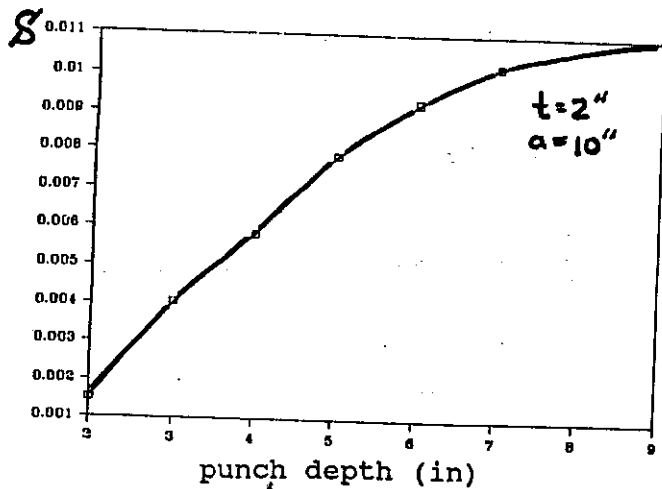

Fig. 13 Sensitivity to plastic modulus

The model presented herein for sequential bending can be used for several purposes. One use demonstrated here is to study process sensitivity to parameter variations. This in turn can be used to develop a statistical picture of the expected variation of the process outputs. For example, the parameters can be described by probability distributions and these in turn can be propagated through the model using the sensitivity gradients to develop a measure of the output's variance.

As previously discussed, this model can be incorporated into a process simulation, which facilitates broader exploration of the process. By evaluating the results of simulated process steps, the designer can obtain information about process behavior in general, and particularly about the trade-offs which are involved in process optimization.

Experimental verification

The sequential bending experiments were performed on a Cincinnati Inc. 90-ton pressbrake. A positive stop system was added to the machine to permit exact control of punch penetration. The workpieces used were $6 \times 21 \times \frac{1}{4}$ -in.-thick HY80 high-strength steel. The objective of the experiments was to bend several pieces to a radius of 18 in., with a 30-

deg arc of approximately constant radius. It should be noted that this radius measurement refers to the radius of the bent plate, measured by a template, without taking the "head" and "tail" of the piece into account. Figure 14 illustrates the die and workpiece used in this experiment and the steps involved in bending a plate.

In bending the plates, an "operator control algorithm" was used. Specifically, a given piece was first bent using a fixed punch penetration over a sequence of evenly spaced bends. The punch penetration was then incremented for the next bend. The amount of penetration change was chosen intuitively, by the "operator" with the intention of "sneaking up" on the desired radius without overbending. During each experiment the bump spacing and sequence of punch penetration values were recorded. Measurement of each radius was done using radius templates.

To verify the model, the exact sequence followed in each experiment was simulated. This involved starting with material properties values gleaned from a series of tension tests performed on the same material, and applying exact measured values of plate thickness, initial geometry and machine geometry to the computer model. After each simulated bend, a measurement program was used to fit a circle to the plate's geometric data. This radius was then compared with the measured intermediate and final radii found experimentally. For each bend, the previously calculated state of geometry was used as an initial description of the plate.

This sequence of steps was carried out for three pieces. In each case, the punch penetration sequence was varied, so as to investigate the effects of changing the bending history of the plate. Tables 1 through 4 give the data obtained for this sequence of three confirmation experiments. From Table 2 it is apparent that the model, as initially calibrated, did not provide accurate predictions of the forming tests. However, as implied by Table 3, this discrepancy was overcome by modifying the initial calibration data, specifically the material properties of yield and strain hardening. These are, as

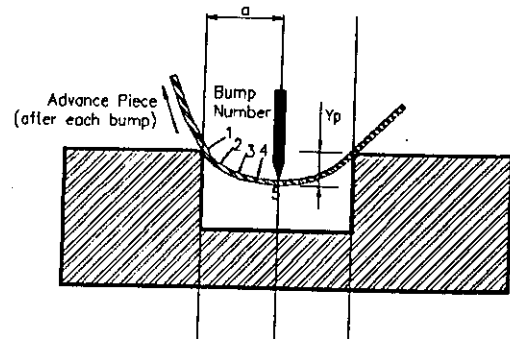

Fig. 14 Press brake and sequential bending illustration

Table 1 Initial model calibration data

| | | |
|----------------------------|---------------------|-----|
| Plate thickness | = 0.278 | in. |
| Plate width | = 6.0 | in. |
| Plate length | = 21.0 | in. |
| E | = 3.0×10^7 | psi |
| E_p/E | = 0.15 | |
| σ_y | = 90,000 | psi |
| a (die half-width) | = 2.4 | in. |
| Y_p (punch penetr.) | = VARIED | |
| ΔBS (bump spacing) | = 1.25 | in. |
| No. of bumps | = 11 | |

Table 2 Experimental results and initial model predictions
(dimensions in inches)

| Plate No. | Bend | Y_p | R_{avg} (exptl.) | R_{avg} (model) |
|-----------|------|-------|--------------------|-------------------|
| 01 | 1 | 0.204 | 21.1 | 15.70 |
| | 2 | 0.220 | 20.9 | 15.70 |
| | 3 | 0.236 | 20.1 | 15.68 |
| | 4 | 0.268 | 18.0 | 13.77 |
| 02 | 1 | 0.173 | 22.0 | 18.99 |
| | 2 | 0.236 | 20.5 | 15.66 |
| | 3 | 0.268 | 18.0 | 13.75 |
| 03 | 1 | 0.236 | 17.8 | 13.32 |

Table 3 Modified model calibration data

| | | |
|----------------------------|---------------------|-----|
| Plate thickness | = 0.278 | in. |
| Plate width | = 6.0 | in. |
| Plate length | = 21.0 | in. |
| E | = 3.0×10^7 | psi |
| E_p/E | = 0.25 | |
| σ_y | = 100 000 | psi |
| a (die half-width) | = 2.4 | in. |
| Y_p (punch penetr.) | = VARIED | |
| ΔBS (bump spacing) | = 1.25 | in. |
| No. of bumps | = 11 | |

Table 4 Experimental results and revised model predictions
(dimensions in inches)

| Plate No. | Bend | Y_p | R_{avg} (exptl.) | R_{avg} (model) |
|-----------|------|-------|--------------------|-------------------|
| 01 | 1 | 0.204 | 21.1 | 20.87 |
| | 2 | 0.220 | 20.9 | 20.87 |
| | 3 | 0.236 | 20.1 | 19.88 |
| | 4 | 0.268 | 18.0 | 16.78 |
| 02 | 1 | 0.173 | 22.0 | 22.50 |
| | 2 | 0.236 | 20.5 | 17.57 |
| | 3 | 0.268 | 18.0 | 15.46 |
| 03 | 1 | 0.236 | 17.8 | 17.30 |

the desired outputs of plate radius and residual stresses. In addition, the model will provide sensitivity functions for these outputs with respect to material property and geometry variations.

The basic geometry of the process is shown in Fig. 15. The model employed here is based on one developed by Hansen et al. [7]. Only the basic form of the model is presented here. The basic calculations follow much of what is described above, except that the shape of the plate is different between incoming and outgoing sides. While the same triangular moment distribution applies here, the incoming material sees this as a loading moment; thus the loading portion of the $M-K$ relationship is applied to find $K_1(s)$. However, once the material passes the center roll, it is unloading, and the $M-K$ relationship becomes linear. Thus, a nonsymmetric $K_1(s)$ will result. This greatly complicates the calculation of the center roll penetration since this is found by integrating plate curvature to find plate contour. As a result, the execution of the model requires iterative calculations that seek to match roll penetration, boundary conditions and plate shape.

As opposed to bending, rolling does not have the process "freedom" to modify input, since there is only one—the center roll displacement. However, the model does allow one to examine the effect of process uncertainty and to explore the effects of machine geometry (that is, roll spacing and radius). Since the roll bending process does indeed ensure circular parts, the main use of the model at this point is to generate sensitivity functions so that process optimization studies and statistics propagation can be performed. For example, the effect of thickness on center roll displacement can be seen by the data in Fig. 16. Clearly, variations in material thickness will cause significant errors if the roll displacement is not corrected.

This process model, like the bending model, can be incorporated into a process simulation scheme. The graphics and user interface features (Ultrix/X-Windows based) which have been developed can be used with either process model. This approach also supports the implementation of control algo-

expected, the most indeterminate of the process parameters, and such variations can be expected. Comparing Tables 2 and 4, it can be seen that this reestimation of these material parameters results in much improved model predictions. Also, it is significant to note that the model successfully predicts the radius of the plates for three different bending histories. The first plate was bent much more gradually than Plates 2 and 3; however good agreement between the model predictions and the experimental results can be seen in Table 4 for all three plates. This is due to the fact that this process model takes the "initial" geometry of the plate into account before running each iteration of the simulation.

It is readily apparent that by modifying the initial values of material parameters slightly, agreement between the model and the experimental data was obtained. A primary source of error in this experiment was the initial lack of flatness of the plate used. This plate was found to be out of flat by as much as 0.050 in. Correction for this lack of flatness was made in the "runs" shown in Table 4.

Roll bending model

The objective of this model is to relate the process input (roll diameters, spacing and center roll displacement) to

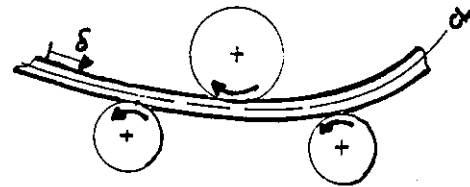

Fig. 15 Roll bending geometry

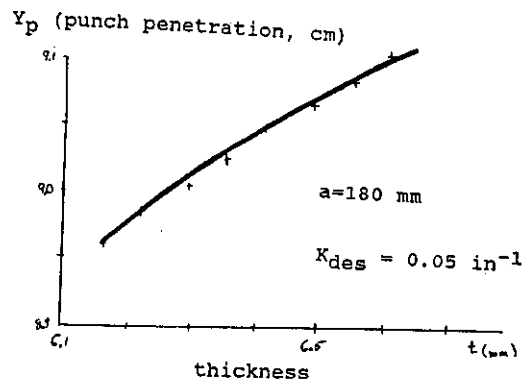

Fig. 16 Effect of thickness on roll displacement

rithm and measurement programs for the simulation of various fabrication methods.

Conclusions

Design-oriented process simulations can provide a wealth of information. It is constructive and useful to provide the ship designer with tools that permit the investigation of process-oriented questions through accurate simulation. The prototype presented here, for the investigation of the sequential plate bending and roll forming processes, is an example of such a "designer-focused" tool. The implementation of such tools at the ship design stage would result in a better product since fabrication considerations could then be evaluated by the designer in a simple yet thorough manner.

Acknowledgments

The authors would like to express appreciation to the Department of the Navy, Office of Naval Research for their support. Funding was received under research agreements N00014-87-K-0462 (Type 2) and N00014-89-J-1187 (Type 1).

References

- 1 Eagar, T. and Moshaiov, A., "Modeling of Welding Distortion in Complex Structures" in *Proceedings, MIT Sea Grants Conference, M.I.T., Cambridge, Mass., 1988.*
- 2 Gallo, M., "A Computer-Aided Interactive Model for the Design of the Manufacturing Process for a Submarine Hull," S.M. Thesis, Department of Mechanical Engineering, M.I.T., Cambridge, Mass., 1988.
- 3 Patrikalakis, N., "Shape Interrogation" in *Proceedings, MIT Sea Grants Conference, M.I.T., Cambridge, Mass., 1988.*
- 4 Hardt, D. E. and Chen, B., "Control of a Sequential Brakeforming Process," *Transactions, American Society of Mechanical Engineers, Journal of Engineering for Industry, May 1985.*
- 5 Queener, C. A. and DeAngelis, R. J., "Elastic Springback and Residual Stresses in Sheet Metal Formed by Bending," *Transactions, American Society for Metals, Vol. 61, 1968.*
- 6 Stelson, K. A., "An Adaptive Pressbrake Control Using an Elastic-Plastic Model," *Transactions, American Society of Mechanical Engineers, Journal of Engineering for Industry, Vol. 104, Nov. 1982.*
- 7 Hansen, N. E. and Jannerup, O., "Modeling of Elastic-Plastic Bending of Beams using a Roller Bending Machine," *Transactions, American Society of Mechanical Engineers, Journal of Engineering for Industry, Vol. 101, 1979, pp. 304-310.*
- 8 Wright, A., "Manufacturing Models of Metal Forming Processes for Design: Rolling and Bending," S.M. Thesis, Department of Mechanical Engineering, M.I.T., Cambridge, Mass., 1988.
- 9 Box, G. and Draper, N. R., *Empirical Model Building and Response Surfaces*, Wiley, New York, 1987.
- 10 Taguchi, G. and Wu, Y., *Introduction to Off-Line Quality Control*, ASI, Dearborn, Mich., 1980.
- 11 Storch, R. L. and Gribskov, J. R., "Accuracy Control for U.S. Shipyards," *JOURNAL OF SHIP PRODUCTION, Vol. 1, No. 1, Feb. 1985, pp. 64-77.*
- 12 Storch, R. L., "Accuracy Control Variation-Merging Equations: A Case Study of Their Applications in U.S. Shipyards," *JOURNAL OF SHIP PRODUCTION, Vol. 1, No. 2, May 1985, pp. 133-144.*

Metric Conversion Factors

1 in. = 25.4 mm
1 psi = 6.895 kPa